

relaxmyway

CANOO V





< relaxmyway

Since the company was founded in the year 2000, the name CASADA has stood for high grade products in the area of wellness and fitness.

Today, CASADA products are available worldwide in 37 countries. What distinguishes CASADA products is their continuous development, unmistakable design and their absolute focus on improving quality of life as well as their reliable and excellent quality.

Congratulations

By purchasing this massage device you have demonstrated an awareness for your health.

So that you can benefit from the advantages of this device for a long time, we would ask you read and observe the safety instructions carefully.

We hope you have much enjoyment your personal Canoo V.

Contents

18	Safety instructions
20	Equipment
21	Assembly
22	Remote control
23	Specials
24	Control panel
26	Finishing the massage
27	Maintenance
28	Troubleshooting
28	Specifications
29	EU-Declaration of Conformity
29	Warranty conditions

Safety instructions



I. THE FOLLOWING PERSONS SHOULD ONLY USE THE DEVICE AFTER CONSULTING A DOCTOR:

- Persons who are mildly affected by electro-magnetic waves, such as users of pace makers or similar devices.
- Persons suffering from a malignant tumour.
- Persons with heart disease.
- Women who are menstruating, are pregnant or have just given birth.
- Persons suffering from diabetes and thus reduced sensory functions.
- Persons with skin lesions in the part of the body to be massaged.
- Persons with a body temperature of more than 38 °C (fever).
- Persons suffering from acute inflammation / injuries at advanced stages (with symptoms such as tiredness, shivering, labile blood pressure, etc.).
- Persons suffering from extreme exhaustion.
- Persons suffering from osteoporosis, bruises or pulled muscles, fractures etc.
- Persons who are sensitive to heat and pain.
- Persons who cannot consciously move their legs and feet.
- Persons with feet that are smaller than 21 cm should refrain from using this device.
- Persons who are not capable of expressing their thoughts clearly and persons who have no or limited movements should not use this device.
- Persons who have been forbidden from having massages by the doctor should refrain from using this device.
- Persons with thrombosis, severe aneurysm, acute venous aneurysm, all types of skin rashes and skin diseases, etc.

II. PLEASE OBSERVE THE FOLLOWING WHEN USING THIS DEVICE:

- Use ONLY the plug provided. (other plugs can lead to electric shocks, failure of the device or a fire).
- Before use please ensure that the fabric cover is not damaged in any places. Should you discover a hole, stop using the device and send it for repair immediately.
- Before adjusting the angle of the device, please ensure that there are no people, animals or other obstacles in the immediate vicinity. There is a risk of entrapment.
- After use the power plug must be unplugged and the device must be stowed and secured in such a way that small children or pets do not get injured.
- During application do not sit on a movable chair that could for example roll. This will prevent you from being injured by the moving chair.
- Do not wrap the power cable around the device.
- Improper handling and force with the power cable can cause damage and can result in fire, electric shocks and similar accidents.
- Nobody is allowed to make changes, modifications or repairs to this product except for dedicated technical staff. This will automatically void the guarantee.
- Please ensure that the power plug is removed during cleaning. Furthermore, do not pull the power plug out with wet hands. This can lead to serious accidents.

Safety instructions

- If you begin to feel unwell when using the device, then stop the treatment immediately.
- The massage should not exceed 2 x 30 minutes per day for each part of the body. The body must be able to relax even after a massage.
- Do not pull on the power plug when pulling out the cable. Disconnect the plug. Furthermore, you should remove dust from the power plug regularly.
- If using the device after a long period of non-use, first ensure that the device is functioning normally and that the power cable is in order. Furthermore, you should remove dust from it frequently.
- Stow the device in a dry area. Dust and moisture have an effect on the device over a long period of time and can lead to an electric shock, defect or fire.
- This massage device is only intended for massage of the legs and the feet. Please do not use it for massaging the head, the chest, the stomach, the knee, the elbow or similar body parts.
- Do not pull on the cable of the controller and do not wind the controller's own cable around it. This can lead to damage of the cable.
- Do not let children use the device and do not allow children in the vicinity of the device when in use.
- Do not sit or stand on the device. This can cause damage and accidents.
- Do not step too firmly on the massage device.
- Do not place your hands or fingers in to the gap between the base and the side wall of the inside of the machine. There is a danger of getting your hand squeezed in if you adjust the angle of the machine or if the machine is in an unlocked state.
- Please do not set your feet down as shown in the picture. (This can easily lead to accidents or injuries.)
- If the power cable is damaged it must be replaced by the manufacturer, its customer service or a similar establishment.
- Please do not damage, modify, pull, bend or wind the power cable excessively. (This can damage the cable and lead to fire or electric shock)
- If the power cable or the plug is damaged or if the socket is loose, do not use the device. It can easily lead to electric shock, short-circuits, fires or similar accidents.
- Do not let the device come into contact with water in any way.
- Please do not use the device at the same time as other electronic devices. (This can lead to problems/overburdening of the body).
- Please do not use the device if it is wrapped or covered in a towel or blanket (this can lead to a fire or a higher indoor temperature).
- Do not stick your hands in the gaps between the massage heads, there is a danger of getting your hand squeezed in.
- Please do not use the device in a bathroom or a location with high humidity.
- If the power cable is damaged, it must be replaced by the manufacturer or retailer in order to avoid further damage.

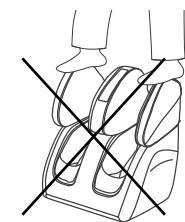
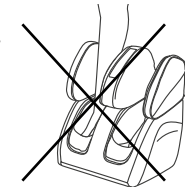
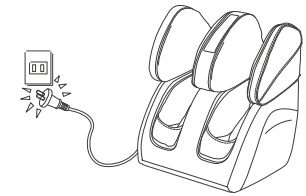

Equipment

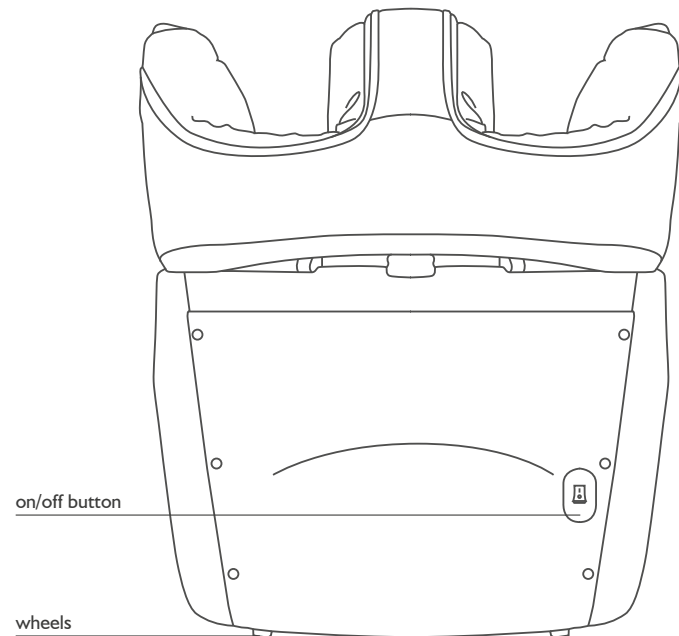
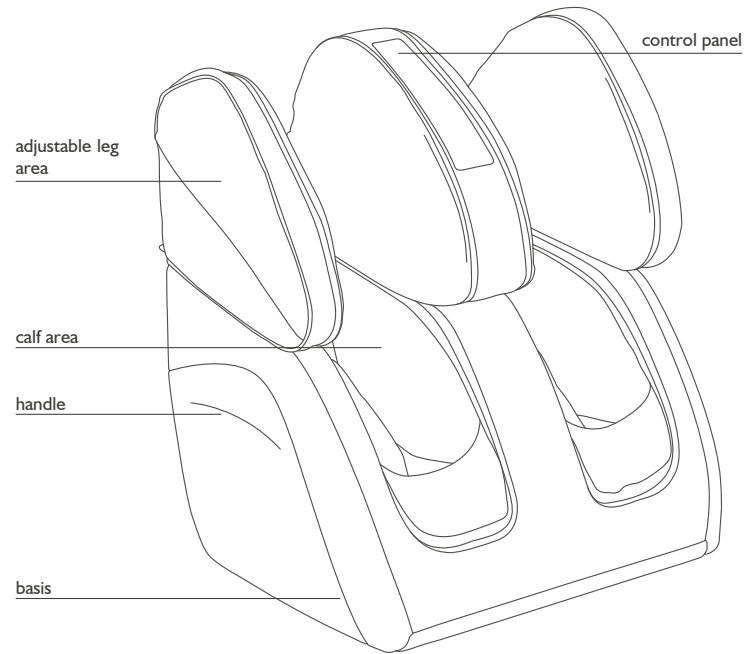

Assembly

1. Place the massaging device on an even surface. Position the device at least 1 metre from TVs, radios or a similar AV device.
2. Before use you must check whether the fabric cover is intact. If you use the device with a defect fabric cover, there is a risk of an electric shock and injury.
3. Insert the power plug fully into the socket.
4. Sit down on a sofa, a chair or something similar and place your legs into the massaging device. Slide the heels backwards. Set the massaging device to the desired angle.

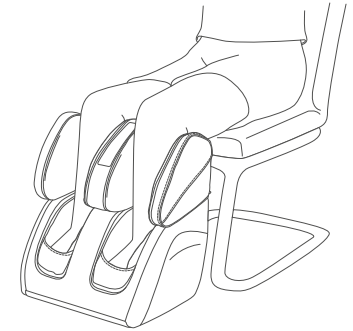

Do not sit on a chair with wheels during use. This can lead to injury. Sit comfortably and maintain a normal body posture.

5. Adjusting the leg area: The upper leg area can be adjusted/pulled out in order to treat the knee and thigh areas.

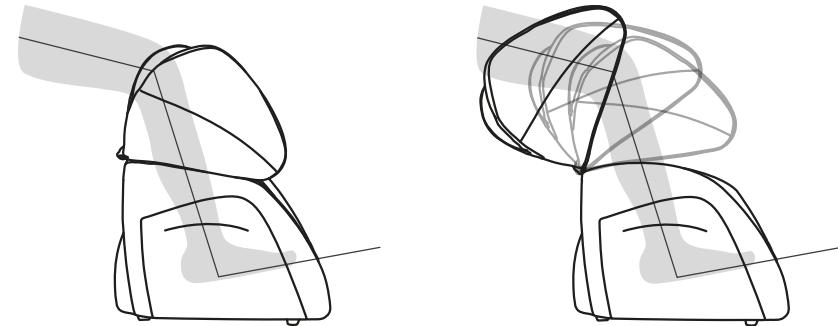

Use your hand to pull out the adjustable part of the legroom upwards. The angle can be adjusted according to your needs.

Remote control

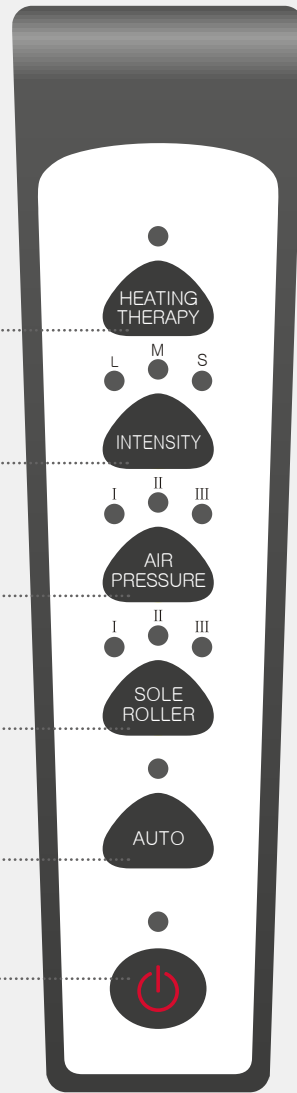

HEATING THERAPY

Warming function for legs and ankles

INTENSITY

3 levels

AIR PRESSURE

selectable areas

SOLE ROLLER

3 different modes selectable

AUTO

Automatic programme

ON / OFF

ON/OFF button

Specials

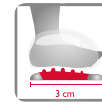

GUA SHA

The scraping of -GuaSha- with slight pressure opens superficial blood vessels and stimulates blood circulation. GuaSha is often applied in combination with acupressure „shu points“ to bring additional stimulation to relieve ache symptoms.

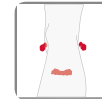

ACUPRESSURE POINTS

Key acupressure points on the, calves and ankles are massaged.



THIGHS

The upper part of Canoo V bends up to 110 degrees and gives you the choice of a knee or thigh acupressure massage.



SUPPORT BRACKET

The tilting support bracket mounted on the front of the appliance allows Canoo V to be adjusted to a 20 degree angle.



TRANSPORTATION

Two rollers at the back of the appliance means the Canoo V can be transported and positioned easily.



AIR COMPRESSION

Rising and receding airbags have a pumping motion which produces natural muscle reflexes. This is particularly beneficial in the calf and foot area.



HEATING

A deep penetrating and heat-radiating effect in which one can perfectly relax. This function is particularly beneficial for muscle tension due to the deep reaching effect.



REFLEXOLOGY

Reflexology regenerates foot muscles and has a harmonizing effect on almost all organs inside your body.





SOLE ROLLER

Deluxe foot massage – even the of the foot rollers can be adjusted.

Control panel

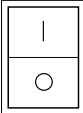
OPERATION

Button	Description
	Power supply, Switching On/Off
	ON/OFF button If you press the ON/OFF button, the display light lights up and the device is ready for use. The treatment is ended by pressing the button again. The device is now in standby mode.





AUTOMATIC PROGRAMME

Button	Description
	<p>Canoo V's finely tuned, automated programme offers you a massage with:</p> <ul style="list-style-type: none"> • 44 different sized under-the-foot massage rollers. • 30 airbags distributed over the feet, calves, and either the knee or thigh areas • optional heat function • 15 minute running time <p>Whilst in AUTO mode, the air pressure and intensity can be changed or switched off completely if desired. Please note that the intensity function only works in combination with the air pressure.</p> <p>If the air pressure and intensity functions remain switched off during AUTO mode, the Canoo V will only carry out the Sole Roller massage.</p> <p>If you press the Sole Roller massage whilst in AUTO mode, the AUTO programme will automatically be switched to manual mode.</p> <p>The LED light indicates whether the mode has been activated.</p>

Control panel

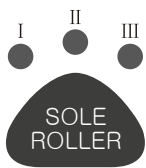
MANUAL OPERATION

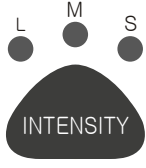

To operate the appliance manually, press the AUTO button until the indicator light is off, then select either the desired mode or a combination of massage functions. Please note that the recommended duration of usage is 15 minutes.

Button	Description
	<p>By pressing this button, the appliance will always go into one of the 3 GuaSha foot massage modes. 3 massaging rollers with 4 tracks, 2 massaging rollers with 4 different sized roller balls and 1 roller with 4 tracks and 3 different roller balls (for the heel, mid-foot and toes).</p> <p>The LED light indicates which mode has been activated. To completely turn this mode off, press the button 4 times.</p> <ul style="list-style-type: none"> I → All rollers massage at the same time. II → All rollers massage in intervals 6x short half turns + 2 long full turns. III → All rollers massage in intervals 5x short half turns + 2 long full turns.
	<p>Select which of the 3 various air pressure massages you want. The LED light indicates which mode has been activated. To completely turn this mode off, press the button four times.</p> <ul style="list-style-type: none"> I → All Airbags II → Foot airbags III → Thigh airbags
	<p>Select which of the 3 various air pressure strengths you want during the air pressure massage. The LED indicator light will show which strength has been activated. To completely turn this mode off, press the button four times.</p> <ul style="list-style-type: none"> L → Gentle M → Medium S → Strong
	<p>The heat function for the thigh and ankle airbags can be turned on and off in both the AUTO and manual mode. This mode can also be used without activating the foot massage or airbag functions.</p> <p>Please note the recommended duration of usage is 15 minutes. The LED light indicates whether the mode has been activated.</p>

Finishing the massage

SAFETY DEVICE

If too much pressure is exerted on the massage heads they stop moving. If this happens, please disconnect the power plug, wait 3 seconds and insert the power plug once more. Then you can use the device again.

Button	Description
	Press the ON/OFF button to end the massage.
 WARNING	The device must be disconnected from the power supply after each use. The massaging device must be set back into its original position and stowed away. If you do not use the device for a long period of time then make sure to disconnect the power plug.

Bring the massage device back to its starting position.

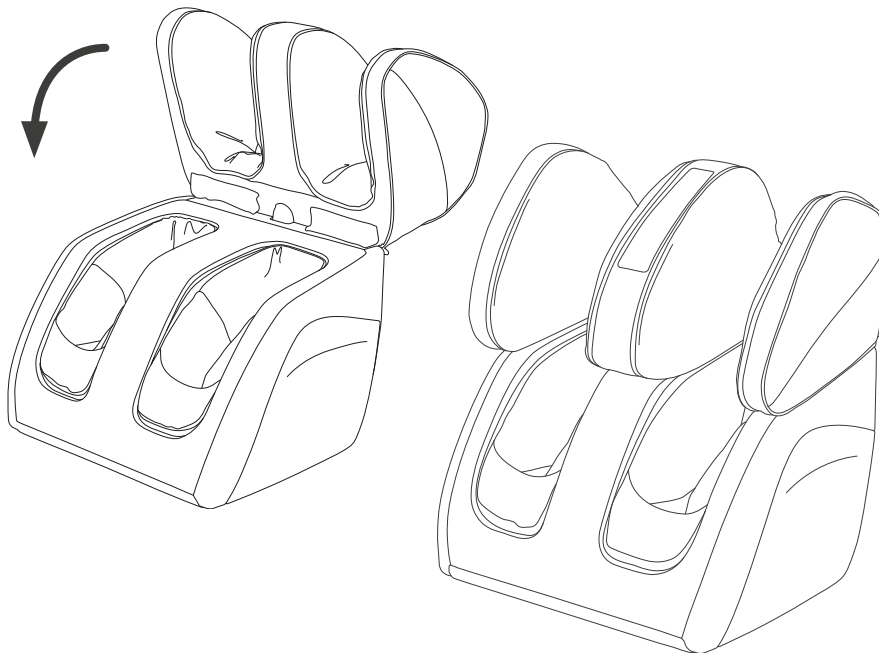

Maintenance



- The power plug must be disconnected for cleaning and maintenance.
- Do not touch the power plug with wet hands.
- Please do not use benzene, thinner, bleach etc. This can lead to colour change, deformation or damage.
- Exercise caution when cleaning the fabric. If the fabric appears to be damaged, do not use it any longer. Contact our customer service in order to avoid injuries.
- NEVER use the device without fabric!
- Please do not leave small children in the vicinity of the device after removing the fabric. This can lead to accidents or injury.

- Use a neutral cleaning agent with lower concentration and a soft cloth. This can be used to clean the device. Use just a small amount of moisture!
- Use this to wipe the surface and then follow with a dry cloth.
- Removing and washing the fabric cover:

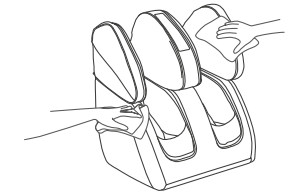
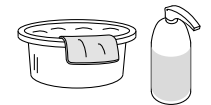

- [1] First, pull the adjustable parts of the leg area upwards
- [2] Locate the zip fastener in the fabric cover.
- [3] Open this in the direction of the arrow and remove the fabric.
- [4] Use the washed fabric only once it is dry again.

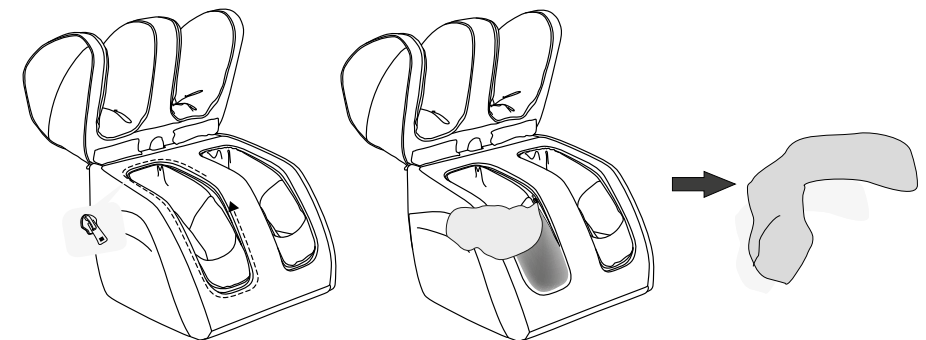

Troubleshooting

If the following information does not help you to resolve the problem, please contact our customer service centre.

Problem	Analysis of the malfunction	Solution
Device does not work	The power plug is not plugged in.	Ensure that the voltage required for the device matches the local mains voltage of the socket and insert the plug once more.
	After 15 minutes the device switches to standby mode.	If you wish to be massaged again, then press the ON/OFF button once more.
	If you use the device for 30 minutes without interruption, then a mechanism in the massage cuts out to stop it from overheating.	If you wish to use the device once more, then unplug the power cable and let the device cool down for 60 minutes.
	Heavy objects are on top of the unit.	Disconnect the power plug and connect it again once you have removed the heavy object.
The device becomes very hot	You are being massaged by the device for longer than 30 minutes.	Disconnect the power plug and let the device cool down. Please disconnect the power plug after every use.
The device makes a noise	This noise comes from the working components of the mechanics.	This noise is normal and does not indicate a malfunction.

Specifications Canoo V

- Dimensions: 45 x 54 x 60 cm
- Weight: 24,5 kg net/ 27 kg gross
- Voltage: AC 110-120 V ~ 60 Hz
AC 220-240 V ~ 50/60 Hz
- Nominal power: max. 120 Watt
- Automatic runtime: 15 Minutes

Certificates:



EU-declaration of conformity

Complies with European Regulatory Standards EMC 2014/30/EU, LVD 2014/35/EU.

Warranty conditions

The retailer guarantees a statutory period of warranty for the product described on the reverse. The warranty applies from the date of purchase. The purchase date is to be shown on the proof of purchase. The retailer will repair or replace products that are registered within Germany in which a defect has been found free of charge. This does not include parts subject to wear such as fabric covers. The requirement is that the defect device is sent in with proof of purchase before expiration of the warranty period.

The warranty claim shall not be applicable if a defect is determined that has been caused e.g. by external influences or as the result of a repair or modification that has not been carried out by the manufacturer or an authorised dealer. The warranty on the part of the retailer is limited to repair or exchange of the product. Within the framework of this warranty, the manufacturer or retailer will not assume any further liability and is not responsible for damages that have arisen as a result of non-compliance with the operating instructions and/or improper use of the product.

If upon examination of the product by the manufacturer it is found that the warranty request does not concern a defect covered by the warranty or that the warranty period has expired, the customer must bear the costs for the inspection and repair.

Legal note: All contents do not contain healing statements. The diagnosis and treatment of illnesses and other physical disorders require a treatment by a physician, non-medical practitioner or therapist. The statements are strictly informative and may not be used as a substitute for a professional medical treatment. Every user is beholden to ascertain by accurate examination and, if required, after consultation of a specialist, if the application is the right one for their specific cases. Each dose or application takes place at the risk of the user. We dissociate ourselves from any healing statements or promises.

Casada International GmbH
Obermeiers Feld 3
33104 Paderborn, Germany
info@casada.com
www.casada.com

Copyright Images and text are subject to the copyright of CASADA International GmbH and may not be used without express consent.

Copyright © 2016 CASADA International GmbH.
All rights reserved.

